



Omniloc Implant System



Prosthetic Components - Catalog

Impression posts





Internal Octagon
(flat-top) Implants

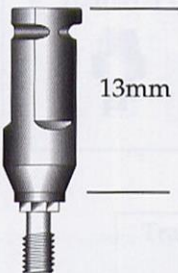
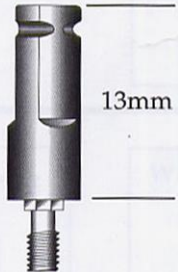

Item/Description	Catalog No.	Qty/Pkg
<p>Indications: For transferring position of implant body analog. Used when the choice of abutment is to be made at a later date. Allows versatility in options and case planning.</p>		
 <p>13mm</p>	<p>3.25mm Two-Piece Impression Post with Retaining Screw</p>	<p>0599 1ea</p>
 <p>13mm</p>	<p>4.0mm Two-Piece Impression Post with Retaining Screw</p>	<p>0699 1ea</p>

Analogs

Image	Item/Description	Catalog No.	Qty/Pkg
	3.25mm Omniloc Body Analog (stainless steel)	0684	1ea
	4.0mm Omniloc Body Analog (stainless steel)	0685	1ea

Straight Fixed abutments

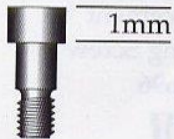

Replacement Retaining Screw

0696

2ea



Item/Description

Indications: Single tooth, custom sub-coping, limited inter-occlusal space. Attaches directly to the implant. Not to be splinted.

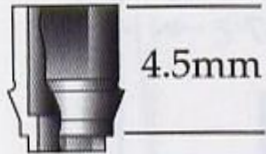

0602

3.25mm Direct Gold Coping

1.5mm Cuff

(cast-to-alloy)

(each set includes: 1 coping and 1 retaining screw 0696)



0601

4.0mm Direct Gold Coping

0.5mm Cuff

(cast-to-alloy)

(each set includes: 1 coping and 1 retaining screw 0696)



Omniloc Direct Gold Waxing Post

0947

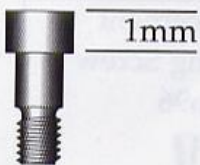

Replacement Retaining Screw

0696

Shouldered Abutments

Indications: Bars, Bridges, Substructures, Fixed detachable. For up to 20° non-parallel.

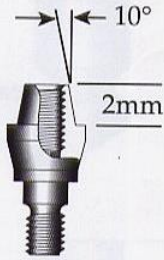

3.25mm Omniloc Shouldered Abutment[†]
2mm cuff

0422

1ea

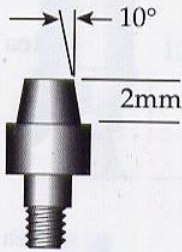

4.0mm Omniloc Shouldered Abutment[†]
2mm cuff
3mm cuff
4mm cuff

0616

1ea

0617

0618



Common Shouldered Abutment Components, 3.25mm & 4.0mm



Shouldered Abutment Transfer Coping

0714

1ea

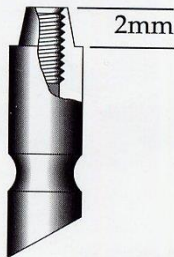

Shouldered Abutment Analog
(stainless steel)

0718

1ea

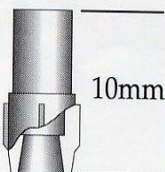

Shouldered Abutment Waxing Sleeve
(plastic, uses pan head coping screw,
0746 or 0603, Page 16)

0724

2ea

Shouldered Abutments



Shouldered Abutment Gold Coping

(uses pan head coping screw
0746 or 0603)

0812

1ea

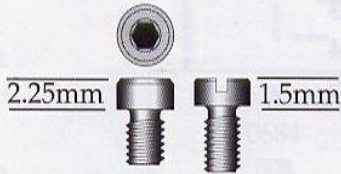

Coping Screw, Hex
Coping Screw, Cross Slot

0746

4ea

O-Ring Attachment



5.3mm

4.0mm O-Ring Attachment*

2mm cuff

0646

1ea

3mm cuff

0647

4mm cuff

0648

5mm cuff

(each set includes: 1 O-Ring attachment,
2 O-Rings and 1 O-Ring retainer)



Integral Implant System



Prosthetic Components - Catalog

Impression posts & Analogs

Impression Posts

Item/Description	Catalog No.	Qty/Pkg
------------------	-------------	---------

Indications: For transferring position of implant body analog. Used when the choice of abutment is to be made at a later date. Allows versatility in options and case planning.

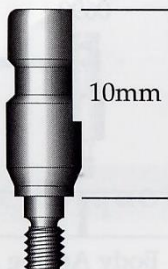

3.25mm Integral Impression Post

0701

1ea



4.0mm Integral Impression Post

0999

1ea

Implant Body Analogs



**3.25mm Integral Implant Body Analog
(stainless steel)**

0431

1ea



**4.0mm Integral Implant Body Analog
(stainless steel)**

0837

1ea

Straight Fixed abutments

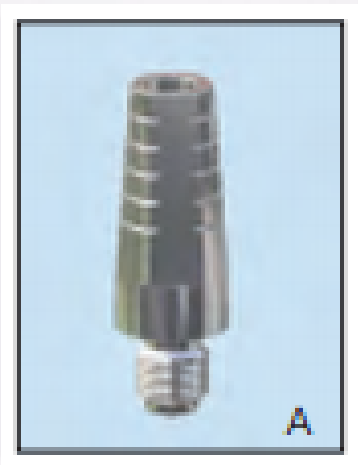

Item/Description	Catalog No.	Qty/Pkg
------------------	-------------	---------

Indications: Used for cemented prosthesis. Can be prepped as needed. Must be splinted. Cemented refers to cement-retained prosthesis.

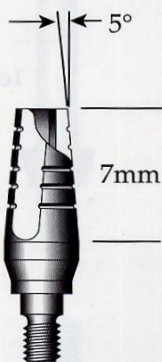

3.25mm Integral Fixed Abutment
(cemented)
2mm cuff

0426

1ea

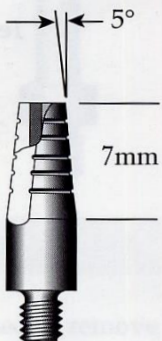



4.0mm Integral Fixed Abutment
(cemented)
2mm cuff

0932

1ea

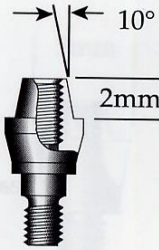
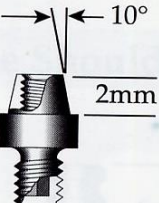
Shouldered Abutments

Item/Description	Catalog No.	Qty/Pkg
Indications: Bars, Bridges, Substructures, Fixed detachable. For up to 20° non-parallel.		
	3.25mm Integral Shouldered Abutment 2mm cuff	0422 1ea
	4.0mm Integral Shouldered Abutment 2mm cuff 3mm cuff 4mm cuff 5mm cuff	 0710 1ea 0711 0712 0713

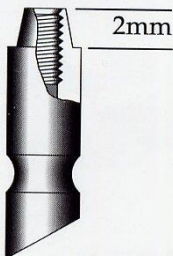
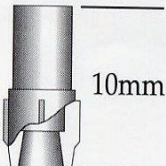

Common Shouldered Abutment Components, 3.25mm & 4.0mm

	Shouldered Abutment Transfer Coping	0714	1ea
	Shouldered Abutment Analog (stainless steel)	0718	1ea
	Shouldered Abutment Waxing Sleeve (plastic, uses pan head coping screw, 0746 or 0603, Page 16)	0724	2ea

Shouldered Abutments



Shouldered Abutment Gold Coping

(uses pan head coping screw
0746 or 0603)

0812

1ea

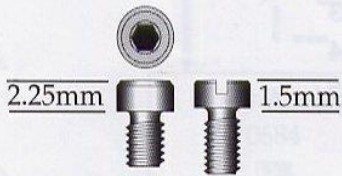

Coping Screw, Hex
Coping Screw, Cross Slot

0746

4ea

0603

O-Ring Attachment



O-Ring Retainer 2/pkg

0767

Connection

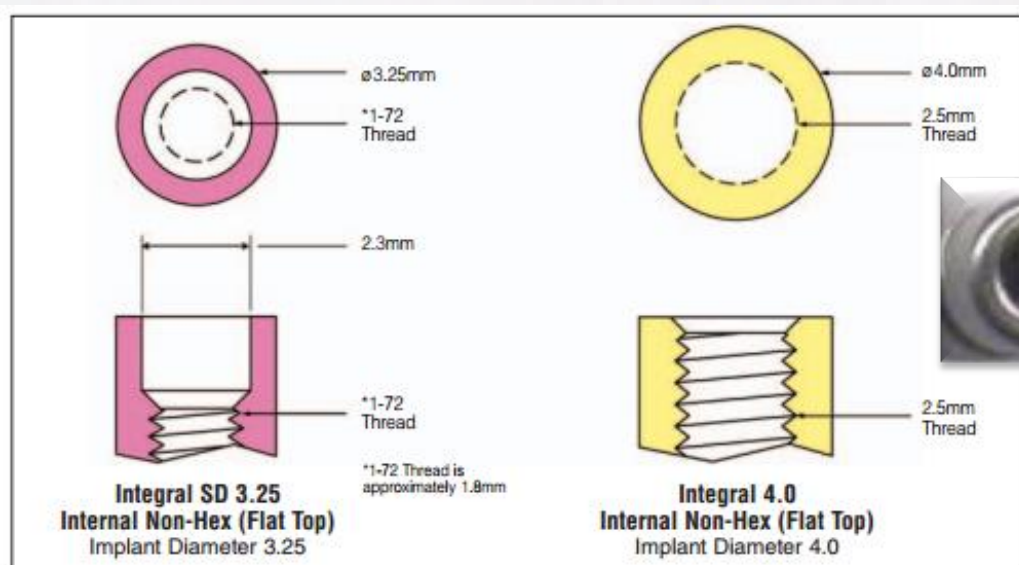

For more information about our Products, Regenerative Materials and Educational Opportunities, contact us:

1900 Aston Avenue
Carlsbad, CA 92008-7308
USA

In the U.S. 1 (800) 854-7019

To fax an order 1 (888) 225-2483

Outside the U.S. +1 (760) 929-4300

Australia +61 (0)2 9950 5434 or 1 (800) 241 916

Canada +1 (905) 567-2073 or 1 (800) 265-0968

Chile +562 231 5185

China +86 21 22115147

France +33 (0)1 45 12 35 35

Germany +49 (0)761 1 56 47 0

Israel +972 (0)3 6124242

Italy +39 0438 37681

Spain +34 93 846 05 43

To receive our eNews visit us at http://www.zimmerdental.com/news_eNewsletterSignUp.aspx



www.zimmerdental.com